

# 900

ANTENAS TV BANDA UHF  
TV ANTENNAS UHF BAND  
ANTENNES TV BANDE UHF

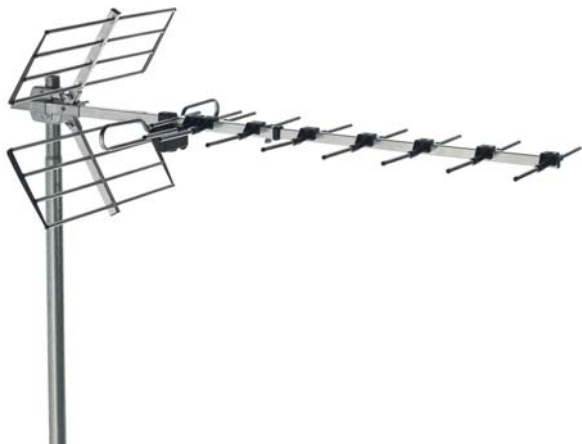

CÓDIGO-CODE-CODE		9000101
MODELO-MODEL-MODELE		BU-268
Rango de frecuencias Frequency range Gamme de fréquences	MHz	470-790
Canales Channels Canaux		21-60
Ganancia Gain Gain	dBd	13
Relación delante/detrás Front/back ratio Rapport avant/arriere	dB	23
Impedancia Impedance Impédance	$\Omega$	75
Pérdidas de retorno Return loss Pertes de retour	dB	$\geq 10$
Polarización Polarity Polarisation		HOR /VER
Ángulo de apertura Beam width Angle d'ouverture	$^{\circ}$ H	26
	$^{\circ}$ V	31
Longitud Lenght Longueur	mm	1087
Resistencia al viento Wind loading Résistance au vent	N   H	48
	N   V	70
Índice de protección Protection index Indice de protection		IP 53

Todas las antenas incorporan simetrizador.  
All antennas supplied with matching transformer.  
Toutes les antennes ont un symétriseur.

CÓMO MONTAR LA ANTENA BU-268  
HOW TO MOUNT THE ANTENNA BU-268  
COMMENT MONTER L'ANTENNE BU-268

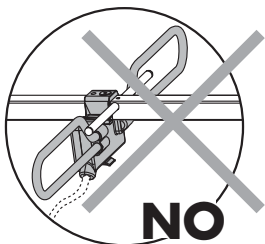
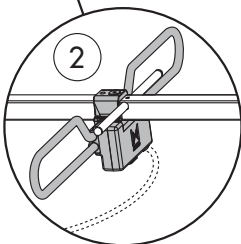
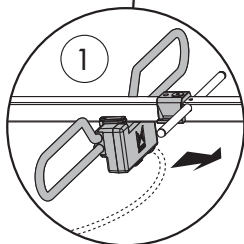
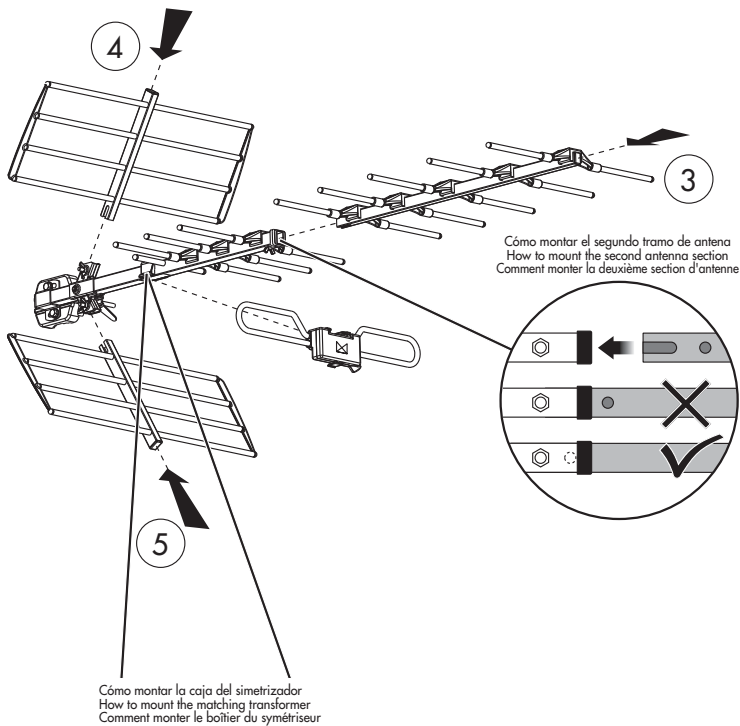

CÓMO CONECTAR EL CABLE COAXIAL EN LA CAJA DEL SIMETRIZADOR  
HOW TO CONNECT THE COAXIAL CABLE TO THE MATCHING TRANSFORMER  
COMMENT RELIER LE CÂBLE COAXIAL DANS LE BOÎTIER DU SYMÉTRISEUR

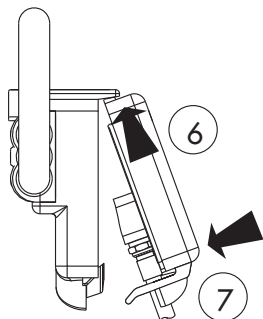
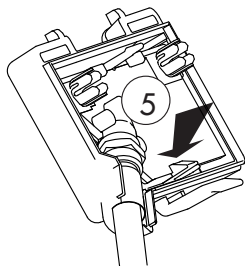
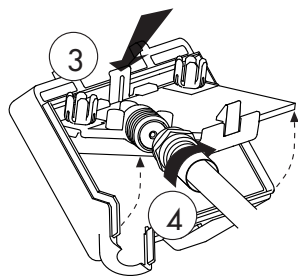
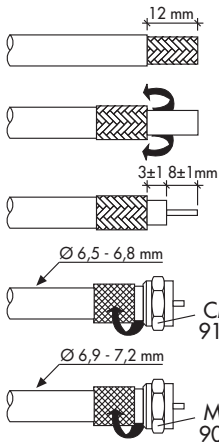
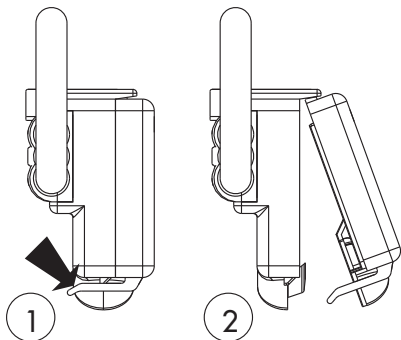

MONTAJE DE LA POLARIDAD HORIZONTAL O VERTICAL  
MOUNTING IN EITHER HORIZONTAL OR VERTICAL POLARITY  
MONTAGE EN HORIZONTAL OU VERTICAL

HORIZONTAL

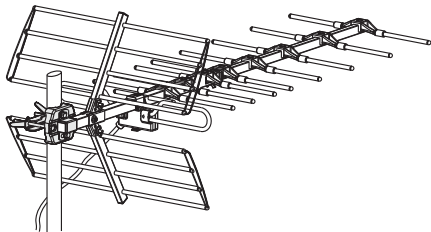

VERTICAL

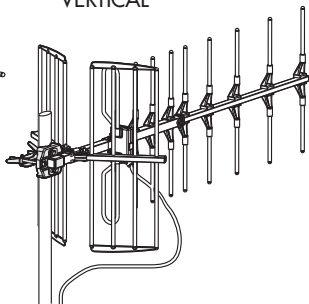

AJUSTE DEL ÁNGULO DE ELEVACIÓN  
ELEVATION ANGLE ADJUSTMENT  
RÉGLAGE DE L'ANGLE D'ELEVATION

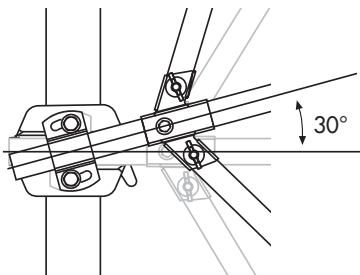

CURVA DE GANANCIA Y DIAGRAMAS DE RADIACIÓN  
GAIN AND RADIATION GRAPHICS  
COURBE DU GAIN ET DIAGRAMME DE RAYONNEMENT

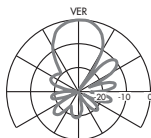
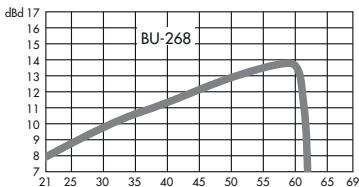



**Company Name:** ALCAD, S.L.  
**Company Address:** Pol. Ind. Arreche-Ugalde, 1  
Apdo. 455, **20305 IRÚN** (Guipúzcoa), **SPAIN**

declares that the product

**Model Number(s):** BU-268  
**Product Description:** TV ANTENNAS UHF BAND  
**Product Option(s):** INCLUDING ALL OPTIONS  
**is in conformity with:** Safety: EN 60728-11:2012

The product herewith complies with the requirements of the Low Voltage Directive 2006/95/EC and the EMC Directive 2004/108/EC.

**Supplementary Information:** To comply with these directives, do not use the products without covers and operate the system as specified.



Irún(SPAIN), 11 July 2014  
Xabier Isasa  
General Manager

Especificaciones sujetas a modificación sin previo aviso  
Specifications subject to modifications without prior notice  
Les spécifications sont soumises à de possible modifications sans avis préalable