

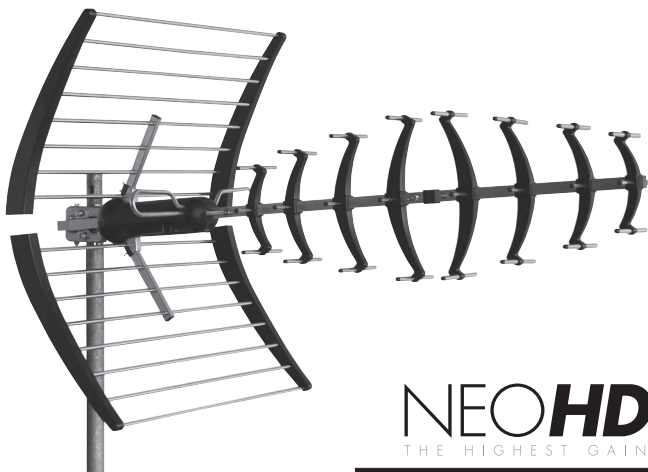

ALCAD

ANTENAS TV BANDA UHF
TV ANTENNAS UHF BAND
ANTENNES TV BANDE UHF



NEOHD
THE HIGHEST GAIN

SERIE 900 SERIES

CODIGO-CODE-CODE		9000185
MODELO-MODEL-MODELE		NEO-085
Rango de frecuencias Frequency range Gamme de fréquences	MHz	470-862
Canales Channels Canaux		21-69
Ganancia Gain Gain	dBi	18
Relación delante/detrás Front/back ratio Rapport avant/arriere	dB	32
Impedancia Impedance Impédance	Ω	75
Pérdidas de retorno Return loss Pertes de retour	dB	≥ 10
Polarización Polarity Polarisation		HOR /VER
Ángulo de apertura Beam width Angle d'ouverture	$^{\circ}$ H	30
	$^{\circ}$ V	28
Longitud Lenght Longueur	mm	1160
Resistencia al viento Wind loading Résistance au vent	N H	125
	N V	95
Índice de protección Protection index Indice de protection		IP 55

Todas las antenas incorporan simetrizador.
All antennas supplied with matching transformer.
Toutes les antennes ont un symétriseur.

CÓMO MONTAR LA ANTENA NEO-085
HOW TO MOUNT THE ANTENNA NEO-085
COMMENT MONTER L'ANTENNE NEO-085

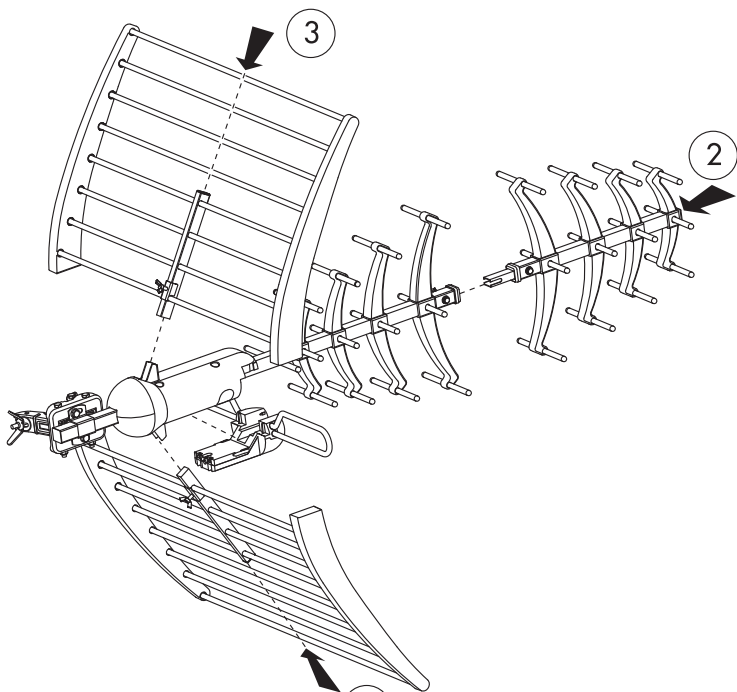

1 Cómo montar la caja del simetizador
How to mount the matching transformer
Comment monter le boîtier du symétriseur

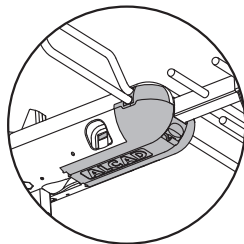
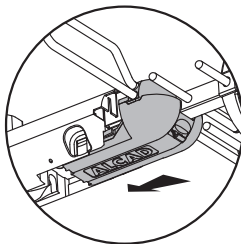
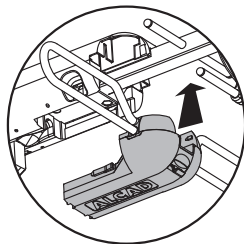

CÓMO FIJAR LA ANTENA AL MÁSTIL
HOW TO ATTACH THE ANTENNA TO THE MAST
COMMENT FIXER L'ANTENNE AU MÂT

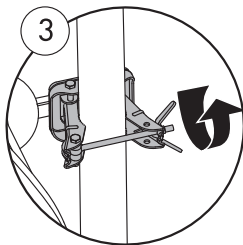
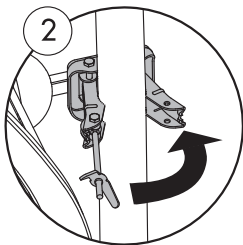
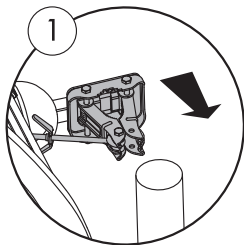
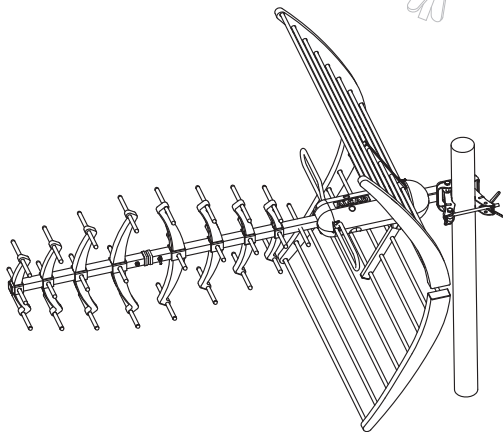
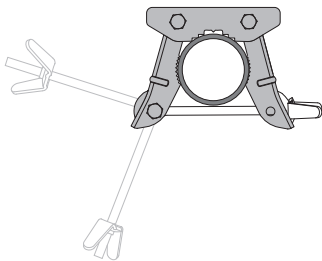
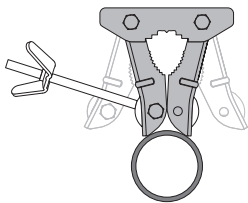

CÓMO CONECTAR EL CABLE COAXIAL EN LA CAJA DEL SIMETRIZADOR
HOW TO CONNECT THE COAXIAL CABLE TO THE MATCHING TRANSFORMER
COMMENT RELIER LE CÂBLE COAXIAL DANS LE BOÎTIER DU SYMÉTRISEUR

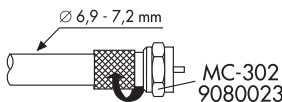
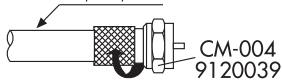
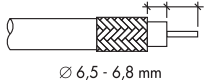
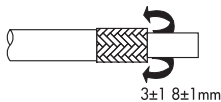
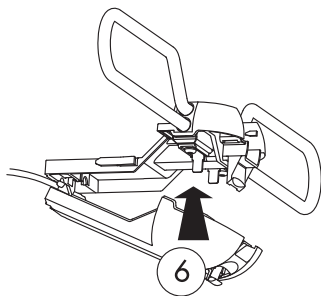
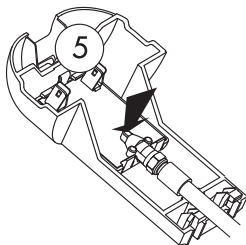
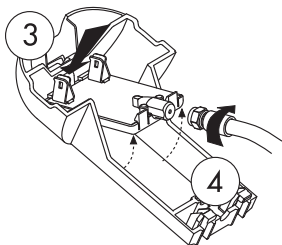
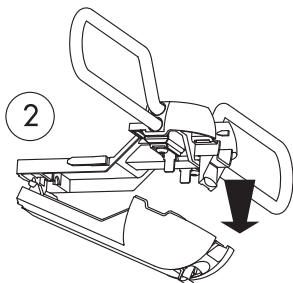
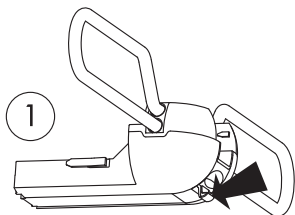

MONTAJE DE LA POLARIDAD HORIZONTAL O VERTICAL
MOUNTING IN EITHER HORIZONTAL OR VERTICAL POLARITY
MONTAGE EN HORIZONTAL OU VERTICAL

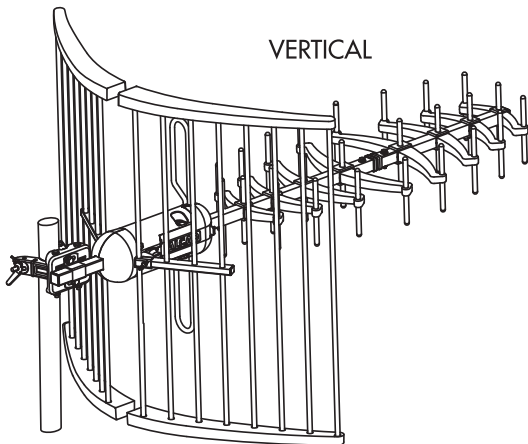
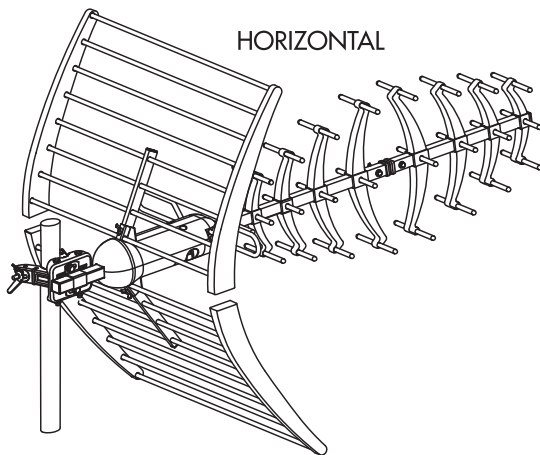

AJUSTE DEL ÁNGULO DE ELEVACIÓN
ELEVATION ANGLE ADJUSTMENT
RÉGLAGE DE L'ANGLE D'ELEVATION

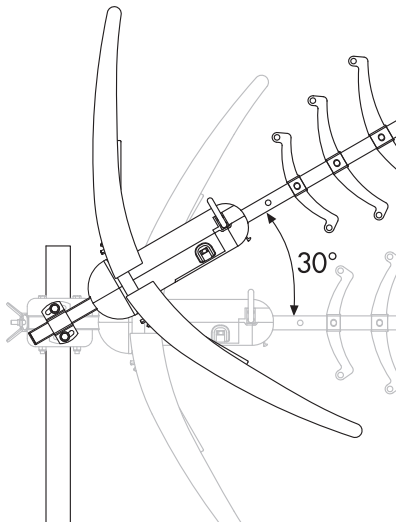

CURVA DE GANANCIA Y DIAGRAMAS DE RADIACIÓN
GAIN AND RADIATION GRAPHICS
COURBE DU GAIN ET DIAGRAMME DE RAYONNEMENT

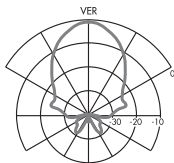
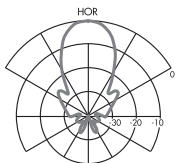
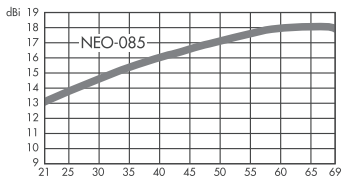

Especificaciones sujetas a modificación sin previo aviso
Specifications subject to modifications without prior notice
Les spécifications sont soumises à de possible modifications sans avis préalable



www.alcadelectronics.com

ALCAD Electronics, S.L.
Pol. Ind. Arreche-Ugalde, 1
Apdo. 455 | 20305 IRUN - Spain
Tel. (+34) 943 63 96 60
info@alcad.net